

- NOTES:
1. ALL DIMENSIONS IN MM [INCH]
  2. GENERAL TOLERANCE: X.X = ±0.4  
X.XX = ±0.25
  3. CONTACT RATING: 50mA @ 12VDC
  4. CONTACT RESISTANCE: 100 mΩ MAX.
  5. INSULATION RESISTANCE: 100MΩ MIN @ 500VDC.
  - ▲ 6. OPERATING FORCE: 100 ± 50gf
  7. TRAVEL: 0.2 ± 0.1mm
  8. OPERATING TEMPERATURE: -25°C to +70°C
  9. OPERATING LIFE: 500,000 CYCLES
  - ▲ 10. LED: YELLOW
  11. ▲ DENOTES CRITICAL PARAMETERS
  12. 2011/65/EU (ROHS) COMPLIANT
  13. PARTS TO BE PACKAGED IN TAPE & REEL, 450 PIECES PER REEL

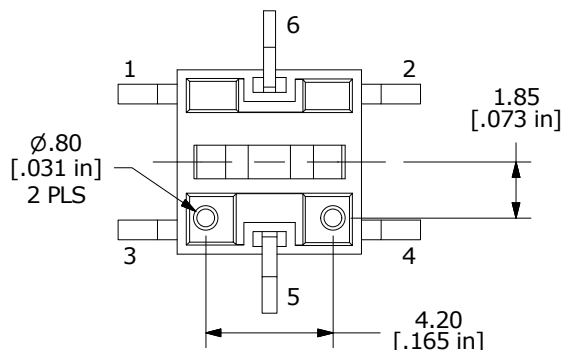

▲ LED SPECS	UNITS	YELLOW
FORWARD CURRENT	mA	20
FORWARD VOLTAGE @20mA	V	2.0 TYP; 2.3 MAX
LUMINOUS INTENSITY @ 20mA	mcd	1500 TYP

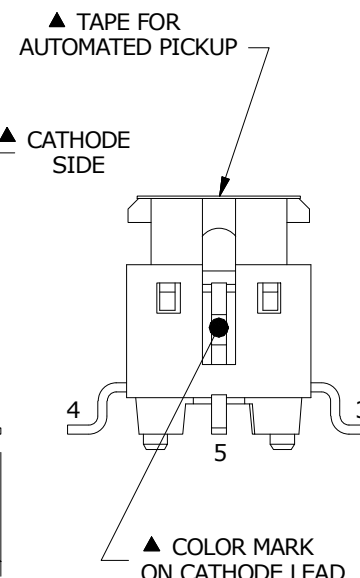
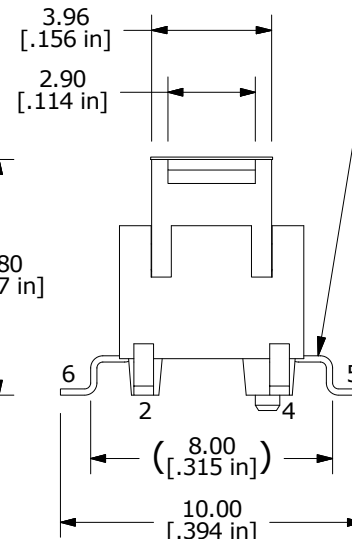
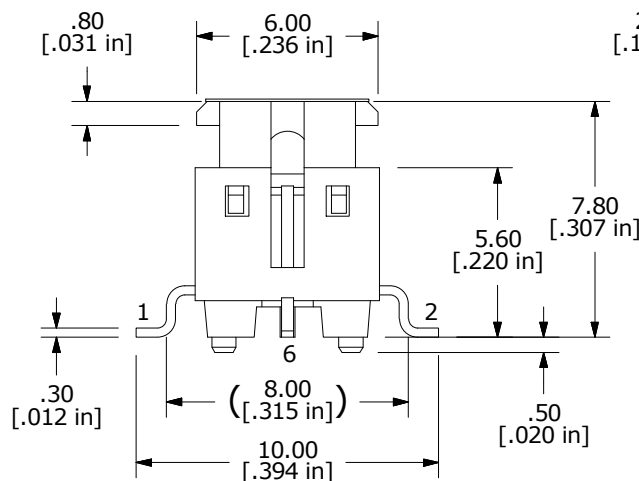
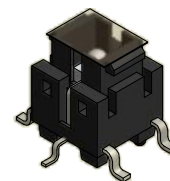
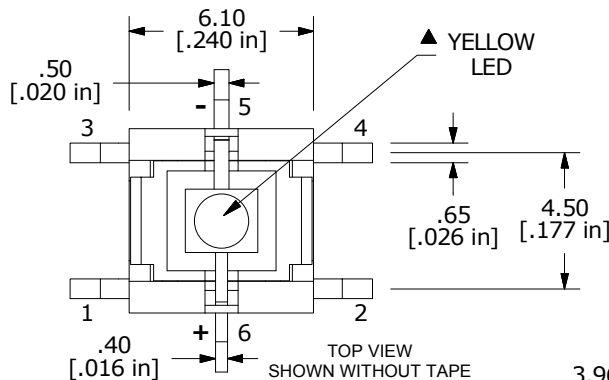

A	22950	Release For Production	8/7/17	MW
REV	PCR NO	DESCRIPTION	DATE	BY

TITLE TL3240F100YT				
SCALE	DATE	DR	DWG	REV
4:1	8/4/2017	MW	N324029	A

THE INFORMATION CONTAINED IN THIS DOCUMENT IS PROPRIETARY TO E-SWITCH AND IS NOT TO BE COPIED OR TRANSFERRED